

Particle size control of detergents in mixed flow spray dryers

Mark Jonathan Crosby¹, Luis Martin De Juan², Elaine Martin¹, Gary Montague¹

¹School of Chemical Engineering and Advanced Materials (CEAM), Biopharmaceutical Bioprocess Technology Centre, Newcastle University, Merz Court, Newcastle-Upon-Tyne NE1 7RU, UK

²Procter and Gamble Technical Centres Ltd., Newcastle Innovation Centre, Whitley Road, Longbenton NE12 9TS, Tyne and Wear, UK
E-mail: mark.crosby@ncl.ac.uk

Published in *The Journal of Engineering*; Received on 18th September 2014; Accepted on 3rd February 2015

Abstract: Particle size is a key quality parameter of a powder detergent as it determines its performance, the bulk density and the look and feel of the product. Consequently, it is essential that particle size is controlled to ensure the consistency of performance when comparing new formulations. The majority of study reported in the literature relating to particle size control, focuses on the spray produced by the atomisation technique. One approach advocated to achieve particle size control is the manipulation of the ratio of the mass slurry rate and mass flow rate of gas used for atomisation. Within this study, ratio control was compared with an automatic cascade loop approach using online measurements of the powder particle size on a small-scale pilot plant. It was concluded that cascade control of the mean particle size, based on manipulating the mass flow rate of gas, resulted in tighter, more responsive control. The effect of a ratio change varied with different formulations and different slurry rates. Furthermore, changes in slurry rate caused complications, as the impact on particle size growth in the dryer is non-linear and difficult to predict. The cascade loop enables further study into the effect of particle size on detergent performance.

Nomenclature

A, B, C	constants
d_L	diameter of liquid nozzle tip (mm)
d_p	particle diameter (μm)
\overline{D}_{32}	mean Sauter diameter (μm)
D_{50}	median diameter (μm)
Oh	Ohnesorge number
S	pump speed (revolutions per minute)
U_R	relative velocity (m/s)
s	second
We	Weber number
μ	viscosity (kg s/m^2)
ρ	density (kg/m^3)
σ	surface tension (N/m)

Subscripts

L	liquid
G	gas
Online	online measurement of parameter
Manual	manual Input of parameter

1 Introduction

In the manufacture of detergents, spray drying provides a rapid method to disperse slurry into liquid droplets and produce a dried powdered product. To understand the spray drying process, knowledge of a number of fundamental aspects of chemical engineering is required including fluid mechanics, mass and heat transfer, reactor engineering, particle technology and material sciences [1]. The particle size distribution (PSD) plays a critical role in all aspects of the drying process, with the distribution determining the contact surface area for heat and mass transfer, and the settling velocity helping determine the residence time and the level of solid-liquid separation in the droplets [2]. The performance of the detergent is dependent on the powder quality, and is described by a series of attributes including flowability, friability, shape, dispersion, colour and activity. Consequently to ensure the quality of the powder, the PSD, along with the bulk density of the powder and its moisture content must be controlled. Furthermore, the drying efficiency, packing and porosity of the powder are dependent on the PSD making it a key quality parameter of the powder detergent.

Spray drying consists of three fundamental processes: liquid atomisation, gas-droplet mixing and the drying of liquid droplets [3]. Liquid atomisation is performed by one of three devices: high pressure nozzles, two-fluid nozzles or rotary atomisers. To produce a spray with high pressure nozzles, the pressure and nozzle-orifice size are manipulated. More specifically, by varying the nozzle pressure, the distribution of droplets produced will change, and the throughput of the nozzle will also be affected. Changing the nozzle orifice will impact on the size of droplets and angle of the spray but this operation can only be carried out offline. The use of two-fluid nozzles provides atomisation at low pressures but the main limitation is low capacity. Through the manipulation of two fluids, greater flexibility is attained in terms of the control of the droplet size distribution. The orifice of the nozzle is selected for the distribution required and the throughput of the process fluid can be maintained by manipulating the level of atomisation of the second. Rotary atomisers produce sprays that are determined by the speed and size of the disk. These atomisers use a centrifugal force to produce a spray from a liquid feed. The force exerted on the liquid can be manipulated by changing the speed of the rotating disk or by choosing a different sized disk. This approach is commonly adopted when handling thick pastes and materials that erode or plug nozzles [3].

Liquid atomisation is the main operation that determines the droplet size distribution entering the process, and therefore is essential for the control of the PSD. However, a number of transformations in the gas-droplet mixing and drying of liquid droplets affect the PSD of the powder exiting from the dryer. The most significant transformations include agglomeration (particle build up) and their attrition (particle break up). These effects are dependent on the material properties of the dispersed liquid and how the dryer system is operated. Compared with co-current and counter-current spray dryers, the air flows in mixed flow spray dryers, provide higher levels of mixing and longer residence times, increasing the impact of agglomeration and attrition on the PSD. This level of mixing provides a high frequency of collisions and the recycling of fines into the spray of droplets improves the overall efficiency of the collisions. As the larger particles spend more time in the dryer, the likelihood of attrition increases as collisions with other large particles are more likely to cause break up [4].

The quality of the control of a spray dryer is dependent on the models used to represent the process. The modelling of a spray

dryer process can be split into four categories of an increasing level of complexity [5]. The initial category describes steady-state heat and mass balances that provide the set points for the slurry rates, air-flows and temperatures in the process. The second category makes use of experimental data to estimate equilibrium data that are subsequently used to parameterise non-steady-state heat and mass balances. The effect of the PSD is taken into account in the third category. In this case, the particles are assumed to be spherical and empirical correlations are used to describe changes in the particle size caused by collisions or shrinkage. The final category uses population balances [6] and computational fluid dynamics [7] to describe particle motion throughout the dryer. Models at this level are computationally demanding and are typically used for process simulation as opposed to online process control. As the complexity of a model increases, it becomes more challenging to utilise it in a model predictive and multivariate control scheme. For multivariable control, a multiple-input–multiple-output scheme is required as PSD is not the only critical parameter to be controlled as it is influenced by the density and moisture content of the powder. The models are dependent on experimental data for the estimation of the material properties and the drying rates of a given product as well as for the training of the model and its subsequent validation. The resulting model provides the desired scheme to operate the process for a given product. When the product is changed, further experimentation is required to undertake model training and validation.

Multiple detergent products are manufactured by spray drying to meet the needs of consumers. Their production is dependent on demand and so flexibility in process operation, and hence the control system is essential. Manual operation and single-input–single-output (SISO) techniques are still favoured by operators and their experience is highly valued as the models available to them fail to deal with transition phases between batches and any upsets in the operation of the spray dryer, such as nozzle blockages. Some models also require recalibration every batch in order to handle dynamic effects such as heat losses throughout the dryer. These models take too long to generate reliable predictions and operators will already have made changes to reflect the conditions identified to them from previous batches of the product. Adopting this approach, assumes that the initial additions, mixing processes and dynamic processes such as heat losses are similar to those of the previous batch. Furthermore, with frequent product changes and updates to operating regulations, model validation becomes even more problematic. This is a common scenario on pilot plants that are used to assess the production and performance of new formulations.

Research has been undertaken to estimate the droplet size distribution using various empirical correlations for different types of atomisers [8], whereas other studies [9] focused specifically on the control of the droplet size distribution produced by two-fluid nozzles. The empirical correlations were validated using water, glass bead and sugar solutions. These correlations were then used to adjust the ratio of the slurry and air mass flow rate and their relative velocities by manipulating the compressed air-flow to the nozzle. Control of the droplet size distribution using a cascade loop to set the air-flow rate has also been reported in the literature using online measurements of the mean Sauter diameter [10]. Both of these methods only take into account the effect of liquid atomisation on the distribution with the experiments not considering the effects of drying and further collisions occurring in a spray dryer. The simple and consistent properties of the water and sugar solutions used to validate the correlations do not replicate the conditions arising in complex slurry flows. Finally, the desired mean particle size (MPS) for detergents is of the order of 300–500 µm and to date two-fluid nozzle configurations have primarily been used in the pharmaceutical industry where the desired MPS is much lower, up to 100 µm. Consequently, the experiments used to validate these correlations produce droplet sizes that are <100 µm and

that have much higher air to slurry mass ratios than those used to produce the desired PSD of detergents. As the ratios used are lower and the sizes of solids in suspension are larger, the correlations described may not be applicable.

Following on from this research carried out with two-fluid nozzle configurations, the research in this paper considers the most appropriate methodology to control the PSD from a spray dryer for complex detergent slurries. It exploits SISO techniques to relate online measurements of particle size to the flow rates based around two-fluid nozzles. The control strategy is required to be sufficiently flexible to control the particle size of a range of formulations on a pilot plant scale mixed flow spray dryer.

2 Materials and methods

The pilot plant scale mixed flow spray dryer system, Fig. 1, consists of two mixers that are used to produce the slurry for the spray dryer. Each mixer is identical with load cells placed below them to measure the change in weight inside the mixer. The slurry is then pumped from one of the mixers to a disintegrator to remove lumps before being fed into the two-fluid nozzle. The slurry is mixed externally with compressed air at the nozzle tip to produce a spray. The spray joins a co-current air-flow and a recycle of fines from the cyclone as it enters the main drying chamber. The droplets are then met by air exiting the fluid bed providing a mixed flow pattern as the air is removed through the exhaust streams at the top of the chamber. The dispersed droplets continue to the fluidised bed where they are fluidised by two air-flows and eluted over an internal weir before exiting the dryer via the outer fluid bed. The powder is then transported via a conveyor belt to the sampling points used to measure the powders properties. The fines produced in the main chamber and fluidised beds are lifted out of the dryer by the air-flows before being separated in the cyclone. The air then travels from the cyclone through a bag filter and out of the exhaust fan. All measurements of flow, temperature and pressure are transmitted to a programmable logic controller (PLC). All control loops are coded in the PLC and can be modified via the PLC or retuned using the operator's graphical user interface (GUI).

A Retsch Technology CAMSIZER was used to measure the MPS of the powder produced from the mixed flow spray dryer process. The instrument works by fitting a normal distribution to the range of particle sizes measured online at the exit of the dryer. The MPS of the estimated distribution is calculated approximately once a minute with a cleaning step occurring between samples that can cause sampling delays. The samples are roughly 1% of the powder produced in the spray dryer and is separated from the bulk product as it leaves the conveyor belt. The MPS is the only variable relating to the PSD that is controlled by the operators with a target of 375 µm.

For the implementation of ratio control, the operator manually sets ratios using the GUI. The operator must determine what change is needed to the air-flow using experience and the online measurement of the MPS. The slurry rate used in the ratio calculation is estimated from an empirical relationship based on the pump speed. This is the preferred option over the use of the load cells under the mixer as the resulting signal is very noisy in contrast to that of the pump speed. The slurry rate is calculated as follows

$$\text{Slurry rate} = \text{Density}_{\text{Manual}} \times (A + B \times S + C \times S^2) \quad (1)$$

where A , B and C are fitted coefficients that are used along with the pump speed, S , to calculate the volumetric flow. The coefficients were obtained by pumping water from the mixers to the dryer where the flow rate of the water exiting the nozzle was measured and compared with the pump speed. Three different flow rates were produced to check the fit was representative at room temperature where the density of water was set to 1000 kgm⁻³. When

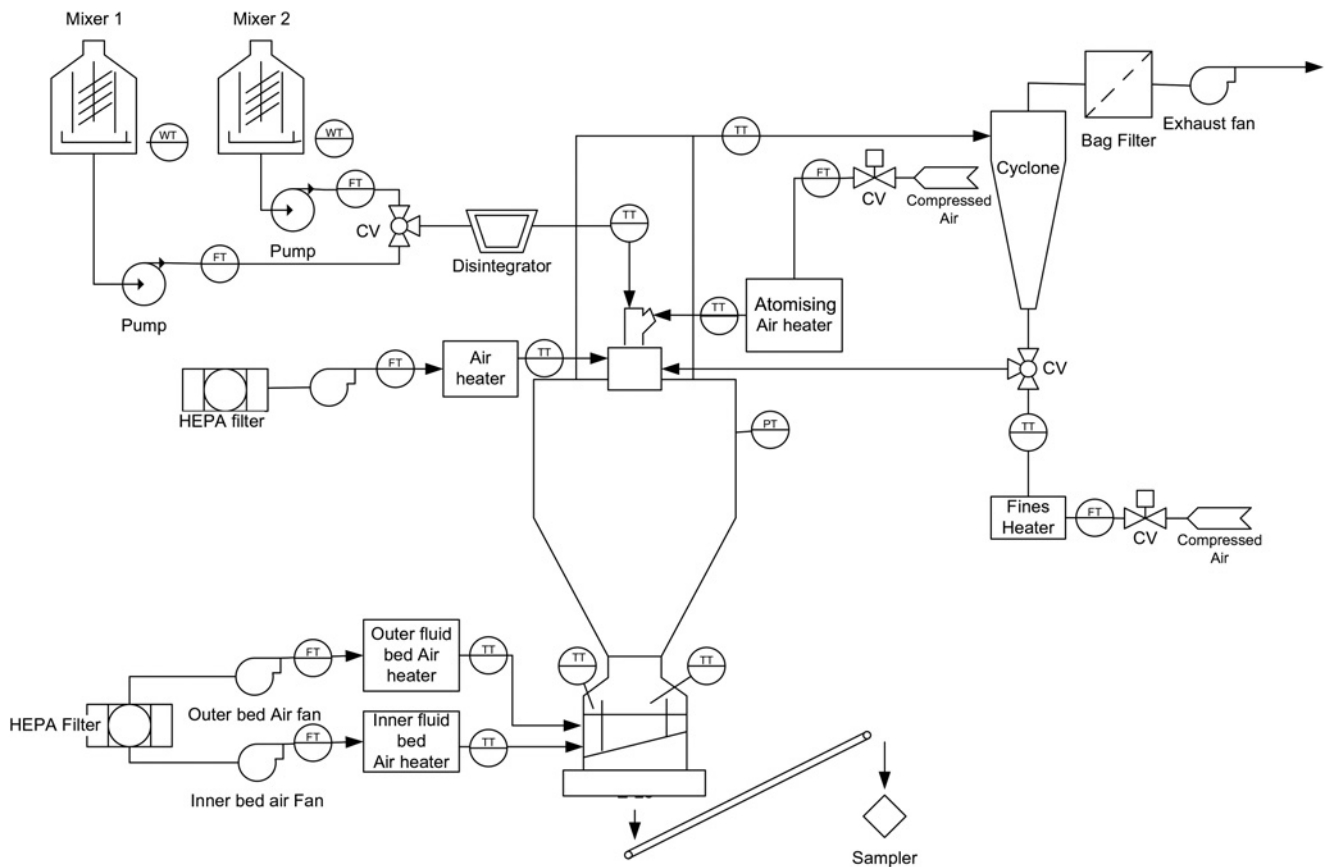

Fig. 1 Piping and instrumentation diagram of mixed flow spray dryer

pumping slurry, manual measurements of density were made at the start of the batch and the operator adjusts the density input until the estimate aligns with the prediction of mass flow rate from the load cell.

The process was simulated using SIMULINK[®] to determine the control parameters in the MPS cascade control loop. A block diagram of the model structure is given in Fig. 2. In this figure, the desired MPS is set and the residual, that is, the difference with the current measured value of the MPS, is manipulated by the proportional–integral (PI) controller. The PI controller converts the residual into a set point for the air-flow fed to the nozzle. The effect of the air-flow rate change in addition to any changes in the slurry rate are summed before taking into account delays caused by the transport of the powder and sampling. The MPS is then measured again and the loop continues until the residual of the set point for MPS and the measured value is minimised.

Implementation of the model depicted in Fig. 2 necessitated that each unit was estimated using historical data. This data were generated from four batches of three different formulations that were considered representative of the portfolio of products produced in the spray dryer. Each formulation had significantly different compositions and required different operating conditions to ensure acceptable product quality. From the historical data, it was determined that the average effect of increasing the compressed air-flow rate to the nozzle by 0.1 kg h^{-1} , the MPS was reduced by $10 \mu\text{m}$ for each batch. For slurry rate deviations, it was found that increasing the slurry rate by 1 kg h^{-1} , resulted in an increase of $15 \mu\text{m}$. To change the air-flow and slurry rates, the PI controllers manipulate an air-flow valve and the pump speed. The dynamics associated with these controllers have also been included to ensure that any change made to these variables takes the appropriate amount of time to reach set point.

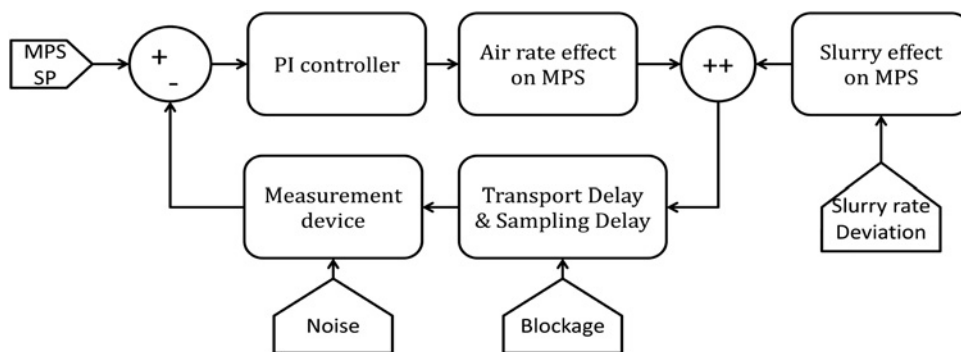

Fig. 2 Model of spray dryer

The transport and sampling delays are introduced to reflect the residence time of the dryer and the time taken to transport the powder to the CAMSIZER via the conveyor belt in order to make a measurement. This was estimated to be 2 min as once the air-flow or slurry rate was manipulated, no significant change could be observed for two to three measurements of the MPS. The two final additions to the model are the effect of blockages and noise. One of the typical problems that materialised on the spray dryer was that it was common for the feed tray to the sampler to block preventing powder from reaching the sampler. This was caused by the combined effect of high flow rates of powder leaving the dryer and wet product sticking to the feeder. This blockage prevented newly produced powder from reaching

the sampling point leading to inaccurate measurements of MPS. Noise was added to the estimated MPS as when running under constant conditions experimentally, the MPS tended to fluctuate around its expected value. During everyday operation of the dryer a blockage is evident, as the MPS will suddenly change by a significant amount. The operator subsequently unblocks the feeder and waits for another measurement. This is easily achieved with manual control as the operator simply ignores the measurement. However, an automatic control strategy will make an unnecessary control action to correct for the sudden change in MPS. If the operator does not observe that there is a blockage, then the loop will continue to change the air-flow to try and correct the error causing the actual MPS to deviate away from set point. Once all the various elements depicted in Fig. 2 were accounted for, the process was simulated with disturbances to the slurry rate so the cascade loop could be auto tuned in SIMULINK®.

Fig. 3 shows the simulation of the MPS, the change in the atomising air-flow rate to control the MPS and the disturbance produced from the slurry rate. In Fig. 3a, the simulated measurement of the MPS shows that there is clear evidence of a delay in the measurement because of the residence time of the dryer system and that the MPS signal is being sampled and held as only one measurement is made every minute. Moreover at 1700 s, an inaccurate measurement has been introduced to simulate a blocked feed tray and to investigate by how much the control loop would cause the MPS to deviate from its set point by changing the air-flow rate to react to the disturbance. Fig. 3b shows the manipulation of the atomiser air-flow by the cascade loop. This is considered to ensure that the control loop does not cause any unnecessary action and provides stable manipulation of the air-flow. As can be seen, there is no oscillation or sharp changes in the air-flow rate while it is manipulated to deal with the disturbance from the slurry rate. The drop at 1700 s was caused by the blocked feed measurement and is quickly rectified once a subsequent measurement is recorded. The speed of response for the controller has been reduced so that the operator has enough time to sort the blockage. Fig. 3c shows the changes in slurry rate from steady state. The slurry rate is a useful measurement when aiming to control moisture content, and hence the control loop would have to deal with these changes during normal operation of the spray drying unit.

3 Theory

Before analysing the performance of ratio control, the rationale as to why ratio control is recommended for MPS control is discussed. The nozzle used in the aforementioned process is a GEA NIRO co-current two-fluid nozzle. The recommended method to control the particle size is through the ratio of the gas and liquid feeds [11]. It is stated that these nozzles are used to produce MPSs in the range 10–40 μm similar to the ranges considered in the literature [10]. The theoretical models they developed, to match their experimental results, related the slurry to air mass ratio to the Sauter mean diameter using the Weber and Ohnesorge numbers, (2) and (3), respectively

$$We = \frac{d_L \rho_G U_R^2}{\sigma} \quad (2)$$

$$Oh = \frac{\mu_L}{\sqrt{\rho_L \sigma d_L}} \quad (3)$$

where the Weber number relates the aerodynamic effects of the gas on the formation of the spray. This metric takes into account the diameter of the nozzle tip, d_L gas density, ρ_G surface tension, σ and the relative velocity of the air and slurry U_R . The Ohnesorge number is a dimensionless number used to describe the effect of viscous forces of the liquid taking into account the viscosity, μ_L and liquid density, ρ_L . Equation (4) proposes a relationship to

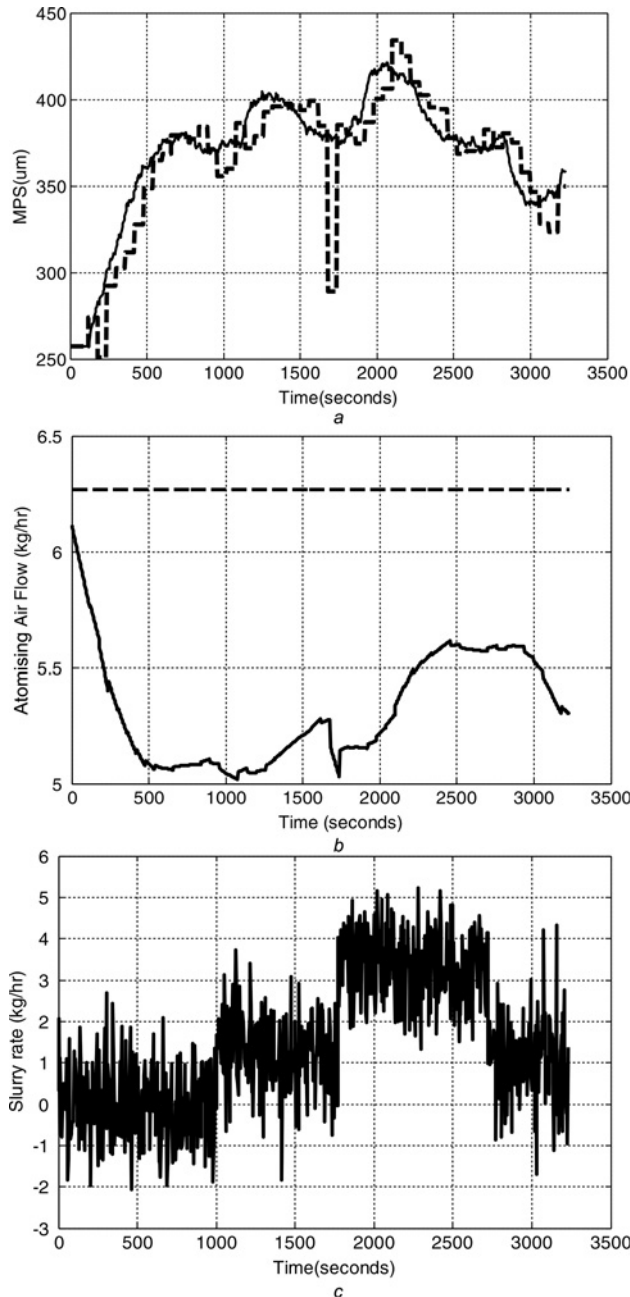

Fig. 3 Simulation of the MPS, the change in the atomising air-flow rate to control the MPS and the disturbance produced from the slurry rate
a Simulated MPS controlled at 375 μm and subject to disturbances, ‘—’MPS, ‘- - -’
b Simulated change in atomising air-flow to control MPS, ‘—’ air-flow, ‘- - -’ initial value
c Simulated change in slurry rate with additional noise from steady state

predict the mean Sauter diameter, $D_{3,2}$ [9]

$$\overline{D_{32}} = 0.21d_L \cdot (\text{Oh})^{0.622} \cdot (\text{Slurry to Air Ratio}/\text{We})^{0.4} \quad (4)$$

Similar correlations were reported in the literature [8] but assumed a linear relationship for the slurry to air ratio. If it is assumed that the materials properties are constant for a given batch, then it follows that for both these correlations, the desired Sauter mean diameter can be maintained by keeping the ratio of slurry to air ratio to Weber number at a fixed value. This means that if the formulation is prepared consistently, then there should be a ratio that will produce the same MPS every time a batch is produced.

4 Results

Slurry to air mass ratio control is currently implemented to operate the spray dryer unit. To assess its performance, 15 batches were run and analysed with the sole goal being for the operator was to attain set points for the powder quality as determined by the moisture content, density and PSD. These 15 batches were performed on three different formulations that typified the range of detergents manufactured. Fig. 4 shows the average performance of the 15 batches and the associated variability, captured in terms of one standard error of the mean. Consequently by assuming a normal distribution, the probability that a measurement falls in this range is 68.2%. This allows the consistency of the control strategy to be analysed on a batch-to-batch basis. Although the measurements of MPS are made once a minute, a moving average determined over three measurements was used to reduce the noise in the signal. By implementing this control strategy, it can be seen that the MPS did not reach its target until ~45 min. The average remains within 40 μm of the target MPS however, considering the standard error of the measurements there remains significant variation around the desired value of MPS. It can be seen that the range is $\pm 50 \mu\text{m}$ showing that the best achievable control in these batches would produce a particle size between 325 and 425 μm . This lies in the desired particle size range of 300–500 μm . However, the moisture content distribution and density are dependent on the PSD and this variability will lead to inconsistent powder quality.

Fig. 5 shows the average performance of 11 batches using the cascade control strategy. Owing to the demand for the unit, seven batches were undertaken with the three formulations used previously with a further four batches carried out using three different formulations. Again for these batches, the operator's goal was to reach the desired product quality. However, for one batch the set point of the MPS was changed to see whether the automatic control loop was able to change from one state to another. As can be observed, the average particle size reaches the target in

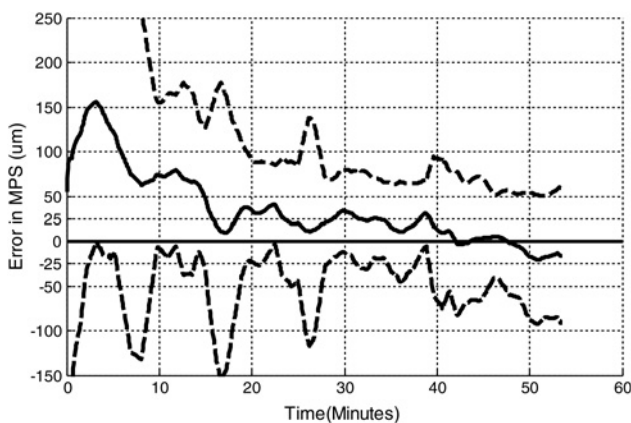

Fig. 4 Average error in MPS for 15 batches using ratio control $\pm \sigma$, '—' average, '- -' $\pm \sigma$

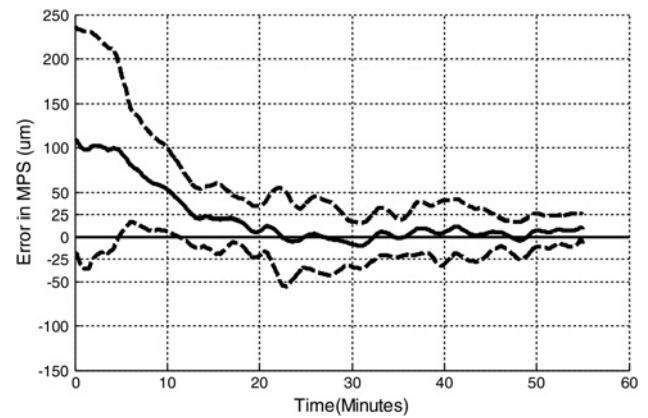

Fig. 5 Average error in MPS for 15 batches using cascade control $\pm \sigma$, '- -' average, '—' $\pm \sigma$

~21 min and the average measurement is within 20 μm of the target MPS and the level of variability remains within $\pm 20 \mu\text{m}$ from 12 min into the batch.

5 Control comparison

Cascade control has resulted in a significant improvement in the control of the PSD compared with ratio control. This is mainly due to the fact that automatic control can be applied, and therefore reacts more quickly than when manual changes are made to the ratio and is self-correcting throughout the batch. More specifically, it is not dependent on the operator observing that the particle size has deviated from the target value. However, the theory indicates that if a certain slurry to air ratio was maintained, then the mean droplet size would remain on target as long as the material properties were constant. This theory only applies to the PSD of the spray and does not relate to the powder produced from a spray dryer. The poor performance of the ratio control is directly linked to the variation in the material properties and to changes in the dryer process dynamics. The slurries produced for the manufacture of detergents consist of a complex four-phase suspension: electrolytes, organics, air and undissolved solids. The mixing of these phases is very difficult to achieve without causing composition gradients as the phases separate within the mixer thereby resulting in deviations in the density. Agitation and temperature control in the mixer are important to ensure consistent slurry is fed to the dryer. In a R&D environment, new formulations are tested which can result in mixing problems, and hence the likelihood of segregation, aeration and sedimentation of the slurry is increased, as there is less understanding of the formulation thereby affecting the value of the Ohnesorge number and potentially causing the mass slurry rate to change. This scenario would not be captured by the empirical pump correlation thereby resulting in the calculated ratio being incorrect. The Ohnesorge number will cause the droplet size produced at atomisation to change and an incorrect estimate of the slurry to air ratio would then mask the cause of the change in the MPS from the operator. An example of changes in flow properties resulting in an incorrect measurement of slurry rate on this unit is shown in Fig. 6. This is an example of the effect of poorly mixed slurries. In this case, the pump speed was kept constant causing the empirical relationship to predict a mass flow rate of 55 kg h^{-1} . Although there is a significant amount of noise in the load cell measurement of the slurry rate, it shows a clear downward trend and as the pump speed was constant, this can only be caused by changes in the material properties of the slurry.

The other issue relating to the ratio control scheme was that changes to the process dynamics caused by the change in atomisation were not taken into consideration. As the slurry rate is changed by the operator, the air-flow is altered to maintain the ratio. The

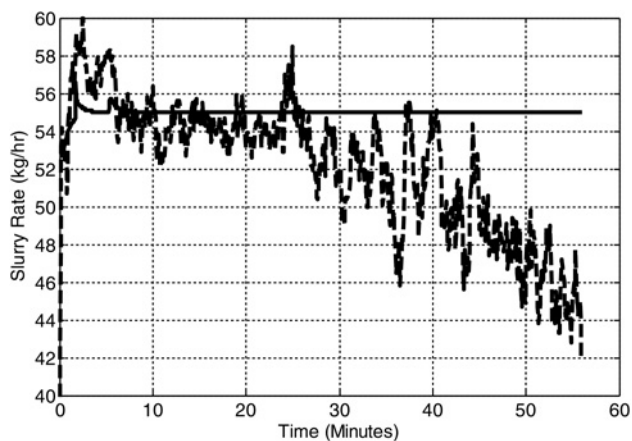

Fig. 6 Changes in slurry rate mass flow at a constant pump speed, '---' empirical pump correlation, '—' load cell measurement

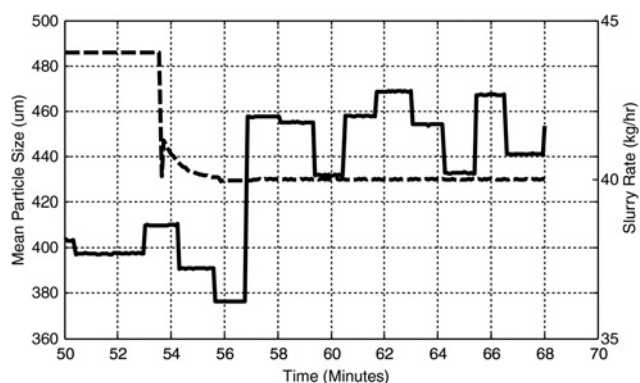

Fig. 7 Positive change in MPS to a decrease in slurry rate, '—' MPS, '---' slurry rate (pump speed prediction)

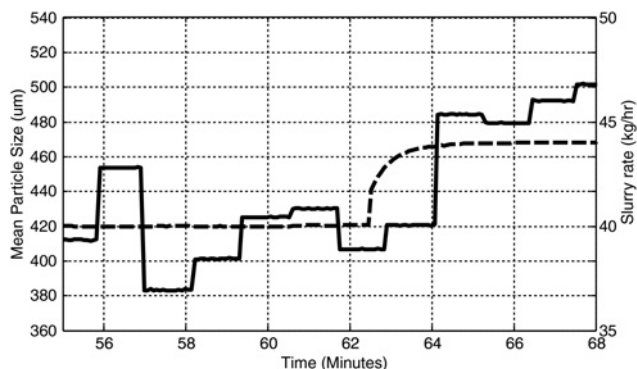

Fig. 8 Positive change in MPS to an increase in slurry rate, '—' MPS, '---' slurry rate (pump speed prediction)

slurry rate is used to control the moisture content of the powder and so variations in the slurry rate are likely to occur during a batch. According to the research discussed, it is proposed that the MPS can be maintained as long as the slurry to air mass ratio is constant. However, there is no measurement of the amount of fines recycling in the process or of the effect of changing the concentration of particles inside the dryer as a result of changing the slurry rate. Figs. 7 and 8 show that by increasing or decreasing the slurry rate, an increase in the particle size can result. In both cases, the mass

slurry to air ratio was maintained but the particle size increased. The reason for this is not yet understood but the change is clearly a consequence of the slurry rate. By treating the slurry rate as an unmeasured disturbance, the cascade loop takes the necessary control action to reduce the effect of the slurry rate change.

6 Conclusions

Cascade control provides more effective automatic control of mixed flow spray dryers than ratio control for the manufacture of detergent. This is as a consequence of the fact that cascade control relates only to the effect of air-flow changes and adjusts the air-flow to deal with any unmeasured disturbances in the slurry rate, slurry properties and any other impacts in the process that effect particle size. The effect of air-flow changes were found to be constant for varying slurry rates for a range of formulations. Ratio control failed to provide suitable control for this dryer system as an accurate estimate of the slurry rate was not achieved. Automatic control using the mass ratio is not feasible as the effect of ratio changes differ for different slurry rates, with different material properties and different formulations and constant manual changes to the ratio would be necessary to control the MPS to its target value. This is unrealistic as it would take too much of the operators time during a batch. With the current portfolio of products, the cascade loop implemented on the pilot scale spray dryer provides more reliable, consistent control of the MPS and relieves a significant amount of pressure on the operator to control numerous variables at the same time.

7 Acknowledgments

Procter & Gamble for providing the Mixed Flow Spray dryer and range of detergents to carry out this research and also the EPSRC for their funding and support, grant number: EP/G037620/1.

8 References

- [1] Langrish T.A.G.: 'Multi-scale mathematical modelling of spray dryers', *J. Food Eng.*, 2009, **93**, (2), pp. 218–228
- [2] Mulhem B., Schulte G., Fritsching U.: 'Solid-liquid separation in suspension atomization', *Chem. Eng. Sci.*, 2006, **61**, (8), pp. 2582–2589
- [3] Genskow L.R., Beimesch W.E., Hecht J.P., Kemp I.C., Langrish T.: Psychrometry, Evaporative Cooling, and Solids Drying. In Pery's Chemical Engineers' Handbook (Eight Edi.) McGraw-Hill Education. Section 12, pp. 12-81–12-86
- [4] Williams A.M., Jones J.R., Paterson A.H.J., Pearce D.L.: 'Effect of fines on agglomeration in spray dryers: an experimental study effect of fines on agglomeration in spray dryers: an experimental study', *Int. J. Food Eng.*, 2009, **5**, (2), pp. 1–36
- [5] Oakley D.E.: 'Spray dryer modeling in theory and practice', *Drying Technol.*, 2004, **22**, (6), pp. 1371–1402
- [6] Seydel P., Blömer J., Bertling J.: 'Modeling particle formation at spray drying using population balances', *Drying Technol.*, 2006, **24**, (2), pp. 137–146
- [7] Birchal V.S., Huang L., Mujumdar A.S., Passos M.L.: 'Spray dryers: modeling and simulation', *Drying Technol.*, 2006, **24**, (3), pp. 359–371
- [8] Lipp C.W.: 'Sprays', in (Eds.): 'Kirk-othmer encyclopedia of chemical technology' Vol. 23 (John Wiley & Sons, Inc., New York, 2000)
- [9] Mulhem B., Fritsching U., Schulte G., Bauchhage K., Str B.: 'IFPRI project – annual report 2004 control of droplet characteristics in liquid atomization with suspended particles 2. Background and project overview', *Chem. Eng.*, 2004, pp. 1–27
- [10] Allen R.M., Bakker H.H.C.: 'Spray dryer control based on online particle size analysis', *Trans. IChemE*, 1994, **72**, Part A
- [11] Gea N.: 'Nozzle atomizers', 2013. [Online]. Available at <http://www.niro.com/NIRO/cmsdoc.nsf/WebDoc/webb8cshg5>, accessed: 09 April 2013, pp. 251–254